

Pressure measurement

Powerful instruments for process pressure, differential pressure, level and flow



Oil & Gas: Fuel for thought

We reduce complexities to help you perform, comply and thrive in the Oil & Gas sector

Although markets can be unpredictable, your operation cannot be. Whether upstream or downstream, you need a partner who understands that you must maintain and maximize plant availability – and do it with ever-tighter resources. From exploration to refinery, storage to distribution, and plant upgrades to new projects – we have the application expertise to help you succeed. At a time when the oil and gas industry faces skills shortages and regulations tightening, our organization is here across the full life cycle of your project always with your deadlines in mind. While complexity of facilities and processes are ever increasing, and downtime must be reduced, your competitiveness is enhanced with reliable, accurate and traceable asset information. In short, you need to do more with less, benefiting from a stable partner who is here for the long haul and ready across the globe, offering:

- Safety in plant operation
- Optimized production and return on investment (ROI)
- High plant availability

✓ Advantages at a glance

- Easy, safe and secure: Bluetooth connectivity for remote operation
- Guided setup sequences: Wizards for easy and intuitive step-by-step guidance via mobile device, Bluetooth or graphic display.
- Globally unique Heartbeat Technology: for the highest level of system safety and measurement integrity.
- Mitigating risks by using state of the art technology meeting highest demands with regard to Functional Safety (IEC 61508) and mechanical integrity (e.g. gastight feedthrough)
- Minimizing operational costs through efficient proof testing concepts, predictive maintenance and innovative data management
- Meeting internationally recognized standards and recommendations such as: API, OIML, ASME, Norsok, NACE etc.
- Increasing plant availability with innovative technologies particularly designed for oil and gas industry applications

Product highlights



Cerabar PMP71B

Digital pressure transmitter with metallic measuring cell; optionally with fully welded diaphragm seal

For pressure, level, volume or mass measurement in liquids or gases. Designed for high pressure applications up to 700 bar and extreme temperature conditions.



Cerabar PMC71B

Digital pressure transmitter with oil-free ceramic measuring cell

For pressure, level, volume or mass measurement in liquids and gases. High degree of system safety thanks to vacuum-proof ceramic membrane with integrated membrane breakage detection.



Deltabar FMD72

Utilizing two fully welded metallic sensor modules and one transmitter

The electronic differential pressure system eliminates traditional mechanical issues resulting in greater process availability and reliability.



Deltabar PMD75B

Differential pressure transmitter with metallic measuring cell

For continuous measurement of pressure differences in liquids, vapours and gases. Extreme pressure resistance thanks to internal overload membrane especially for small measuring ranges.



Deltabar PMD78B

Differential pressure transmitter with one/two diaphragm seals

For continuous measurement of pressure differences in liquids, vapours, gases and dusts. Especially for applications with high temperatures and rough conditions.

Maximum process safety and long-term reliability

Upstream and downstream applications require reliable pressure and differential transmitters that meet the highest safety standards and "last a lifetime". Robust stainless steel housings, modular sensors with highest accuracy and long-term stability and a wide choice of special materials ensure maximum process safety and measurement reliability.

Our solutions go beyond safety, efficiency and compliance.

We offer:

- Wizards for easy and safe step-by-step guidance for commissioning, prooftesting and confirmation of safety-related parameter settings for SIL
- Heartbeat Technology for permanent process and device diagnostics, documented verification without process interruption and information for predictive maintenance
- Highest safety due to secondary containment with gastight feedthrough with functional safety capabilities up to SIL 3, certified to IEC 61508
- Easy ordering and archiving of specific documentation, e.g. NACE, PMI and shipbuilding certificates, welding maps and others
- Easy menu-guided commissioning via graphic display with touch control and backlight for visible on-site diagnostics, 4 to 20 mA with HART, PROFIBUS PA, FOUNDATION Fieldbus
- Easy and remote commissioning and operation via Bluetooth
- Safe and easy engineering documentation with engineering tool Applicator for optimized layout of pressure devices and diaphragm seal systems and level measurement with electronic dp

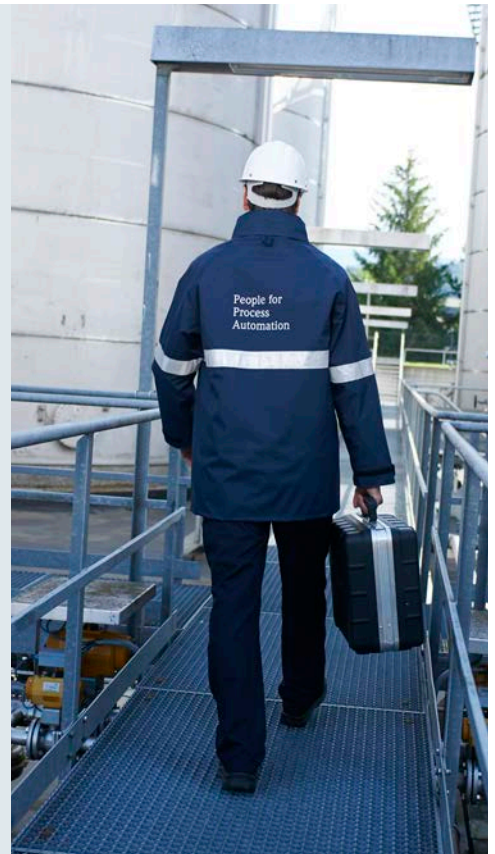



Chemical: Competitive and safe

We help you boost your plant's safety and performance

You gain concrete benefits from a partner who has first-hand knowledge of your sector's issues around the globe: on increased safety, on environmental protection, on over-supply leading to cost pressure and on finding engineering support and service when required. You can rely on our help to become more competitive in your line of business.

With a long history of industry firsts we have grown with the sector by listening, acting and innovating to better serve you with:

- Safety, built in
- The technology to lead
- Best-fit project management

✓ Advantages at a glance

- Easy, safe and secure: Bluetooth connectivity for remote operation
- Guided setup sequences: Wizards for easy and intuitive step-by-step guidance via mobile device, Bluetooth or graphic display.
- Globally unique Heartbeat Technology: for the highest level of system safety and measurement integrity.
- Meeting internationally recognized standards/recommendations: NAMUR, WHG, IP, ASME, NACE, API, IEC 17025, MID, OIML
- Internationally accepted hazardous area approvals: ATEX, IECEx, FM/CSA, NEPSI, TIIS, INMETRO
- Use of state of the art technology – functional safety according to IEC 61508 (up to SIL 3)
- Uniform operating safety by design concepts for simple and safe operations
- Optimized material availability and minimized stocks through inventory management solutions

Product highlights



Cerabar PMC71B

Digital pressure transmitter with oil-free ceramic measuring cell

For pressure, level, volume or mass measurement in liquids and gases. High degree of system safety thanks to vacuum-proof ceramic membrane with integrated breakage detection.



Deltabar PMD75B

Differential pressure transmitter

For continuous measurement of pressure differences in liquids, vapours and gases. Extreme pressure resistance thanks to internal overload membrane especially for small measuring ranges.



Cerabar PMP71B

Digital pressure transmitter with metallic measuring cell; optionally with fully welded diaphragm seal

For pressure, level, volume or mass measurement in liquids or gases. Designed for high pressure applications up to 700 bar and extreme temperature conditions.



Deltabar FMD71

Utilizing two ceramic sensor modules and one transmitter

The electronic differential pressure system eliminates traditional mechanical issues resulting in greater process availability and reliability.



Deltabar PMD78

Differential pressure transmitter with one/two diaphragm seal

For continuous level measurement in liquids.

Maximum process safety and reliability

Pressure measurement in pressurized pipes with aggressive media and level measurements in vacuum distillation columns or rectifiers are typical applications for the Cerabar S pressure and Deltabar S differential pressure product families. Developed according to IEC 61508, highest process safety is realized with the two chamber housing with secondary containment for measurements with functional safety up to SIL 3. Modular sensors with highest accuracy and long-term stability and a wide choice of special materials and process connections ensure maximum process safety and measurement reliability.

Our solutions go beyond safety, efficiency and compliance.

We offer:

- Wizards for easy and safe step-by-step guidance for commissioning, prooftesting and confirmation of safety-related parameter settings for SIL
- Heartbeat Technology for permanent process and device diagnostics, documented verification without process interruption and information for predictive maintenance
- Highest process reliability using application specific materials such as 316L, Ceramic, Alloy C, Monel, Tantal, Gold, PTFE, ...
- Maximum process safety and reliability using robust and vacuum-resistant ceramic cells with integrated membrane breakage detection for pressure measurements even below 1 mbar (0.0145 psi) absolute
- Easy menu-guided commissioning via graphic display with touch control and backlight for visible on-site diagnostics, 4 to 20 mA with HART, PROFIBUS PA, FOUNDATION Fieldbus
- Easy and remote commissioning and operation via Bluetooth





Mining, Minerals & Metals: Extracting more from less

In a world of lower grades, skills gaps and excavation challenges we can help you hit your targets

We've seen how lower grades are driving an acute need for ever-better automation and controls. You are also facing emerging skills gap, requiring better-informed industry partners.

At the same time, energy costs are only going one way, and the legislative environment is becoming increasingly stringent.

Tough challenges call for experienced heads who can:

- Reduce your metal and mineral production costs
- Keep your plant safe
- Boost compliance and responsibility

✓ Advantages at a glance

- Easy, safe and secure: Bluetooth connectivity for remote operation
- Guided setup sequences: Wizards for easy and intuitive step-by-step guidance via mobile device, Bluetooth or graphic display.
- Globally unique Heartbeat Technology: for the highest level of system safety and measurement integrity.
- Complete product basket for all applications, specifically in harsh environments
- Advanced diagnostic functionalities to make the process more safe and reliable
- Savings in raw material, water, energy and labor through accurate data of critical and quality relevant points in your process

Product highlights



Cerabar PMC71B

High performance digital pressure transmitter with oil-free ceramic measuring cell

For pressure, level, volume or mass measurement in liquids and gases. High degree of system safety thanks to abrasion-proof ceramic membrane with integrated membrane breakage detection.



Deltabar FMD71

Utilizing two ceramic sensor modules and one transmitter

The electronic differential pressure system eliminates traditional mechanical issues resulting in greater process availability and reliability.



Cerabar PMC51B

Digital pressure transmitter with oil-free ceramic measuring cell

For pressure, level, volume or mass measurement in liquids and gases. High degree of system safety thanks to robust abrasion-proof ceramic membrane with integrated breakage detection.



Deltabar PMD55B

Differential pressure transmitter with metallic measuring cell

Compact transmitter for flow, level and filter applications.



Cerabar PMC21

Cost-effective pressure transducer with oil-free ceramic measuring cell

For absolute and gauge pressure measurement. Fit for purpose device.

Robust for maximum process safety, efficiency and reliability

The application requirements typically found in cement mills, foundries or mining applications require pressure and differential transmitters that are robust and suitable for the rough application conditions often found in these industries. The ceramic pressure measuring cell is predestined for abrasive applications due the 99.9 % pure Al_2O_3 material and membrane thickness that result in an extremely robust solution.

With a segmented portfolio offering, from highest accuracy and long-term stability to small and compact design, the perfect fit is always given. Our solutions go beyond safety and efficiency.

- Wizards for easy and safe step-by-step guidance for commissioning, proof-testing and confirmation of safety-related parameter settings for SIL
- Heartbeat Technology for permanent process and device diagnostics, documented verification without process interruption and information for predictive maintenance
- Maximum process safety and reliability with robust and abrasion-resistant ceramic cells with integrated membrane breakage detection
- Easy menu-guided commissioning via local display, 4 to 20 mA with HART, PROFIBUS PA, FOUNDATION Fieldbus
- Easy and remote commissioning and operation via Bluetooth
- Safe and easy engineering documentation with engineering tool Applicator for optimized layout of dp flow measuring points, diaphragm seal systems and level measurement with electronic dp
- Minimized maintenance effort, e.g. with retractable pressure transmitter with ceramic membrane for thickeners





Food & Beverage: Trust in quality

We help you to improve quality while reducing operational costs

From hygiene regulations and food safety to the basic demands of reliability and uptime, high quality food & beverage producers profit from our experience in more than 100 countries.

Get it right the first time and make your safe choice:

- Constant food quality & compliance
- Resources savings
- An expert partner

✓ Advantages at a glance

- Complete basket of 3-A, FDA and EHEDG approved pressure and level measurement solutions
- Food safety and reliability due to instruments designed and manufactured specifically for all requirements in Food & Beverage industry
- Savings in raw material, water, energy and labor through accurate data of critical and quality relevant points in your process
- Optimized material availability and minimized stocks through inventory management solutions

Product highlights



Deltapilot FMB50/FMB70

Highest performance pressure transmitter for precise hydrostatic level measurement

Due to its fully temperature compensated and condensation proof Contite cell, Deltapilot is the first choice in condensation applications.



Deltabar FMD71/FMD72

Utilizing two ceramic or fully welded metallic measuring cell modules and one transmitter

The electronic differential pressure system eliminates traditional mechanical issues resulting in greater process availability and reliability.



Cerabar PMC51

Pressure transmitter with oil-free ceramic measuring cell

High degree of application safety thanks to permanent self-monitoring and fully overload resistant ceramic measuring cell, suitable also for condensation applications.



Cerabar PMP55

Digital pressure transmitter with fully welded diaphragm seal

A wide range of diaphragm seals with different process connections, oil fillings and membrane materials allow the adaption to many processes. New TempC Membrane minimizes temperature effects.



Cerabar PMP51

Universal pressure transmitter with compact sensor module

Temperature compensated and with a high variety of process connections and measuring ranges, the PMP51 is the most universal pressure transmitter on the market.



Cerabar PMP23

Fit-for-purpose pressure transducer

The fully welded process connections in 316L paired with IP69 capability in compact version make this transducer the perfect fit for simple monitoring applications in the food and beverages industry.

Maximum food safety and reliability

The application requirements in food and beverages are very challenging especially for pressure sensors: Rapid temperature changes due to CIP/SIP cleaning, wash-down applications requiring IP 69 or condensation formation due to cold processes.

With a segmented portfolio offering, from highest accuracy and long-term stability to small and compact design, the perfect fit is always given. The hygienic design is documented with the industry specific certifications.

With the unique basket of measuring cell technologies, our pressure portfolio always offers the best solution dependent on the specific application requirement:

- Maximum reliability and process safety with condensation-proof ceramic measuring cell with membrane breakage detection
- Deltapilot with hermetically welded condensation-proof Contite measuring cell
- Highest accuracy with temperature compensated metallic measuring cell with small flush-mounted process connections
- Diaphragm seals with patented TempC Membrane for minimal influence due to process and ambient temperature fluctuations





Life Sciences: The pulse of life sciences

Trust a reliable partner who helps you achieve operational excellence

It is a daily requirement to comply with stringent GxP regulations and productivity goals throughout your product lifecycle.

You can count on our world-class instruments, designed to ASME-BPE standards and rely on our experienced engineering and support services. We partner with you to help you reach your goals of process optimization, increased plant availability and continuous improvement. Our experience, gained at the heart of the sector, will help you to:

- Get to market faster
- Boost productivity - manage risk

✓ Advantages at a glance

- Measurement instruments that fully comply with the numerous requirements, codes and standards, such as FDA, ISPE, GAMP, ASME-BPE, EU1935/2004, etc.
- Advanced diagnostics guarantees highest process safety and efficiency
- Products designed for high temperatures and pressures during CIP and SIP processes
- Delivery of products with all required approvals (material certificates for the process wetted parts, certificates of compliance, calibration certificates, surface roughness finish certificates, test reports, etc.)

Product highlights



Cerabar PMP51

Digital pressure transmitter with fully welded metallic measuring cell

For pressure, level, volume or mass measurement in liquids or gases. Available with small flush-mounted process connections.



Deltapilot FMB50

Compact pressure transmitter with the Contite measuring cell

Made for level measurement in liquid and paste-like media in open or closed containers.



Cerabar PMC51

Digital pressure transmitter with oil-free ceramic measuring cell

For pressure, level, volume or mass measurement in liquids and gases. High degree of system safety thanks to vacuum-proof ceramic membrane with integrated breakage detection.



Cerabar PMP75

Digital pressure transmitter with fully welded diaphragm seal

For pressure, level, volume or mass measurement in liquids or gases. Highest accuracy reproducibility and process safety with patented TempC Membrane.



Deltabar FMD72

Utilizing two fully welded metallic sensor modules and one transmitter

The electronic differential pressure system eliminates traditional mechanical issues resulting in greater process availability, reliability and easier installation.



Deltabar FMD78

Differential pressure transmitter with two diaphragm seals

For continuous measurement of pressure differences in liquids, vapours, gases and dusts. Highest accuracy reproducibility and process safety with patented TempC Membrane.

Compliance – Reliability – Availability

The application requirements in the Life Sciences applications are very challenging: Temperature shocks due to sterilization, small pipe diameters that require flush-mounted process connections, right documentation for GMP regulated facilities (IQ/OQ) etc. With a dedicated product portfolio offering, from highest accuracy and long-term stability to small and compact design, the perfect fit is always given. Options for electro-polishing, USP Class VI elastomers and Certificate of Compliance (CoC) according to ASME BPE ensure the suitability also for biotech applications.

With the unique basket of measuring cell technologies, the pressure portfolio of Endress+Hauser always offers the best solution dependent on the specific application requirement:

- Standard process temperature rating of 150 °C for pressure transmitters without diaphragm seal
- Oil-free ceramic measuring cell with integrated membrane breakage detection assures maximum process safety and reduces the risk of contamination
- Highest accuracy with temperature compensated metallic measuring cell with small flush-mounted process connections
- Highest accuracy using diaphragm seals with patented TempC Membrane: Ensures minimal temperature effects and short recovery times also with small membrane diameters
- Easy commissioning and operation: 4 to 20 mA with HART, IO-Link, PROFIBUS PA and FOUNDATION Fieldbus
- TSE free Compliance: no material or ingredients of animal or human origin have been in contact with parts of our products during the entire manufacturing process





Water & Wastewater: Water is our life

Increase your efficiency and ensure compliance with an experienced and trusted partner

As budgets shrink and legislative demands soar, we bring expertise for challenging needs.

Safe potable water... discharges, environmental penalties... water infrastructure for developing countries... energy monitoring... the rising quantities of sludge from wastewater treatment and the opportunities they create for biogas. We make sense of it all, with experienced thinking supported by process technology solutions for your every need.

Through working with water in over 100 countries, Endress+Hauser offers a refreshing alternative.

- Improve plant safety and availability
- Optimize costs in your internal water processes
- Support your risk and failure management

✓ Advantages at a glance

- Easy, safe and secure: Bluetooth connectivity for remote operation
- Guided setup sequences: Wizards for easy and intuitive step-by-step guidance via mobile device, Bluetooth or graphic display.
- Globally unique Heartbeat Technology: for the highest level of system safety and measurement integrity.
- Cost-effective product and service portfolio for any applications, e.g. for drinking water, wastewater and sewage, desalination
- Meeting internationally recognized standards/ recommendations for drinking water applications
- Highest efficiency by easy commissioning, operation and maintenance of instruments

Product highlights



Cerabar PMC51B

Digital pressure transmitter with oil-free ceramic measuring cell

For pressure, level, volume or mass measurement in liquids and gases. High degree of system safety thanks to robust ceramic membrane with integrated breakage detection.



Deltabar PMD55B

Differential pressure transmitter

Compact transmitter for continuous measurement of pressure differences in liquids, vapours and gases.



Deltapilot FMB53

Pressure transmitter with the Contite measuring cell

Made for level measurement in liquid and paste-like media in open or closed containers. Ideal solution for applications with foam formation.



Cerabar PMP11/PMC11

Cost-effective pressure transducer with oil-free ceramic measuring cell or fully welded metallic measuring cell

For continuous gauge pressure measurement in gases or liquids.



Waterpilot FMX21

Reliable and robust level probe with ceramic measuring cell

Certified for drinking water with a robust ceramic sensor and integrated temperature measurement.



Ceraphant PTC31B/PTP31B

Cost-effective pressure switch with oil-free ceramic measuring cell or fully welded metallic measuring cell

For safe measurement and monitoring of absolute and gauge pressure.

Easy to use and absolute reliable

Water and wastewater treatment plants or level probes for surface and/or groundwater applications require robust sensors that are suitable for the ambient conditions often found in these industries. The oil-free and robust ceramic pressure measuring cell is predestined for these applications due to the membrane thickness and resulting robustness. The available housings, electronic inserts and available accessories ensure easy mounting and commissioning.

With a segmented portfolio offering, from highest accuracy and long-term stability to small and compact design, the perfect fit is always given. Our solutions go beyond safety, efficiency and compliance.

We offer:

- Wizards for easy and safe step-by-step guidance for commissioning, proof-testing and confirmation of safety-related parameter settings for SIL
- Heartbeat Technology for permanent process and device diagnostics, documented verification without process interruption and information for predictive maintenance
- Easy on-site commissioning with operation via local LCD display
- Easy and remote commissioning and operation via Bluetooth
- Rod/rope versions with different cable materials ensure wide use
- International drinking water approvals





Power & Energy: Power up your plant

Power plants play a vital role. We help maximize uptime, while delivering safety and productivity.

Today's Power & Energy industry must strike a complex balance: meeting spiraling demand for affordable and reliable energy while increasing cleaner and renewable sources in the energy mix. As cost and regulatory pressures grow, modernization is essential for efficient, safe resource use. As renewables advance, so does the need for energy storage. With best-fit instrumentation, deep power application expertise, services and solutions, Endress+Hauser brings efficient, reliable productivity.

When you choose us, you:

- Boost the efficiency of your plant
- Improve safety
- Retain expertise

✓ Advantages at a glance

- Easy, safe and secure: Bluetooth connectivity for remote operation
- Guided setup sequences: Wizards for easy and intuitive step-by-step guidance via mobile device, Bluetooth or graphic display.
- Globally unique Heartbeat Technology: for the highest level of system safety and measurement integrity.
- Functional safety: IEC 61508 SIL 2/3 certified
- Intelligent instruments with continuous self-monitoring
- Pressure directives such as PED, AD2000, CRN, EN 13480
- Minimized downtime and highest safety through modern instrumentation

Product highlights



Cerabar PMP71B

Digital pressure transmitter with metallic measuring cell; optionally with fully welded diaphragm seal

For pressure, level, volume or mass measurement in liquids or gases. Designed for high pressure applications up to 700 bar and extreme temperature conditions.



Cerabar PMP51B

Digital pressure transmitter with fully welded metallic measuring cell

For pressure, level, volume or mass measurement in liquids or gases. Designed for high pressure applications up to 400 bar (6,000 psi).



Deltabar PMD75B

Differential pressure transmitter

For continuous measurement of pressure differences in liquids, vapours and gases. Extreme pressure resistance thanks to internal overload membrane especially for small measuring ranges. High accuracy up to 0.035 %.



Cerabar PMP21

Cost-effective pressure transducer with fully welded metallic measuring cell

For absolute and gauge pressure measurement up to 400 bar (6,000 psi).



Cerabar PMC71B

Cerabar with ceramic membrane

The ceramic technology is a safe and easy answer to hydrogen applications up to 40 bar, low pressure applications up to 0 mbar abs and complete metal free instrumentation

Robust for maximum process safety and reliability

Pressure measurement in tanks and pressurised pipes are typical applications for the Cerabar S pressure and Deltabar S differential product families. Developed according to IEC 61508, highest process safety is realized with the two chamber housing with secondary containment for measurements with functional safety up to SIL 3. Modular sensors with highest accuracy and long-term stability ensure maximum process safety and measurement reliability. Our solutions go beyond safety and efficiency.

We offer:

- Wizards for easy and safe step-by-step guidance for commissioning, proof-testing and confirmation of safety-related parameter settings for SIL
- Heartbeat Technology for permanent process and device diagnostics, documented verification without process interruption and information for predictive maintenance
- Pressure transmitters for pressures up to 700 bar (10,500 psi) and dp transmitters with pressure ratings up to 420 bar (6,090 psi)
- Easy menu-guided commissioning via local display, 4 to 20 mA with HART, PROFIBUS PA, FOUNDATION Fieldbus
- Easy and remote commissioning and operation via Bluetooth
- Safe and easy engineering documentation with engineering tool Applicator for optimized layout of diaphragm seal systems, dp flow measuring points and level measurement with electronic dp

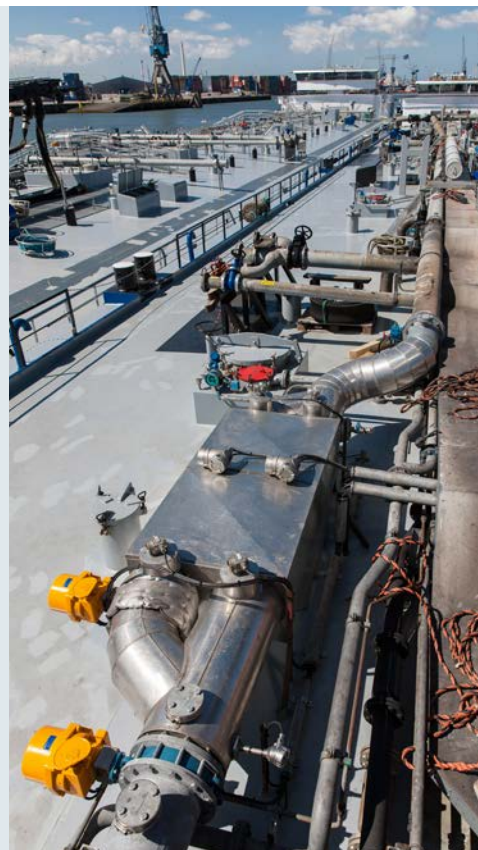

Overview of measuring cell technologies

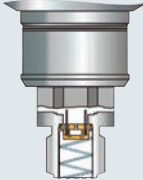
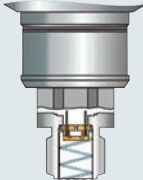
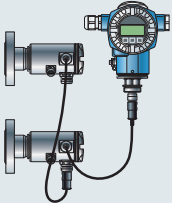
	Description	Measuring principle		
Gauge pressure	Maximum performance and reliability with the right measuring cell technology	Ceramic measuring cell Measuring principle Page 20 Instruments Page 22 	Metallic measuring cell Measuring principle Page 20 Instruments Page 23 	Contite measuring cell Measuring principle Page 20 Instruments Page 24 
Absolute pressure	Maximum performance and reliability with the right measuring cell technology	Ceramic measuring cell Measuring principle Page 20 Instruments Page 22 	Metallic measuring cell Measuring principle Page 20 Instruments Page 23 	Diaphragm seal Measuring principle Page 21 Instruments Page 25 
Differential pressure	Maximum performance and reliability with the right measuring cell technology	Metallic measuring cell Measuring principle Page 20 Instruments Page 26 	electronic dp Measuring principle Page 21 Instruments Page 27 With metallic or ceramic measuring cell 	Diaphragm seal Measuring principle Page 21 Instruments Page 28 
Hydrostatic pressure	Maximum performance and reliability with the right measuring cell technology and system architecture	Ceramic measuring cell Measuring principle Page 20 Instruments Page 22, 27 and 29 	Metallic measuring cell Measuring principle Page 20 Instruments Page 23, 27 	electronic dp Measuring principle Page 21 Instruments Page 27 With metallic or ceramic measuring cell 
Accessories	We offer accessories needed for safe and correct installation of pressure / differential pressure transmitters.	Accessories Page 31 		

Diaphragm seal
 Measuring principle
 Page 21
 Instruments
 Page 25

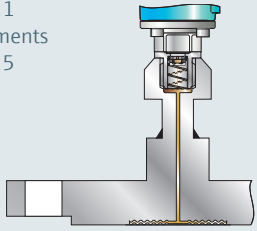

Pressure switch
 Measuring principle
 Page 21
 Instruments
 Page 30

With metallic
 or ceramic
 measuring cell

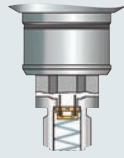

Pressure switch
 Measuring principle
 Page 21
 Instruments
 Page 30

With metallic
 or ceramic
 measuring cell

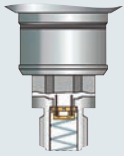
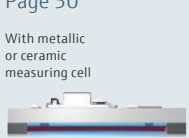

Contite measuring cell
 Measuring principle
 Page 20
 Instruments
 Page 24



Diaphragm seal
 Measuring principle
 Page 21
 Instruments
 Page 28

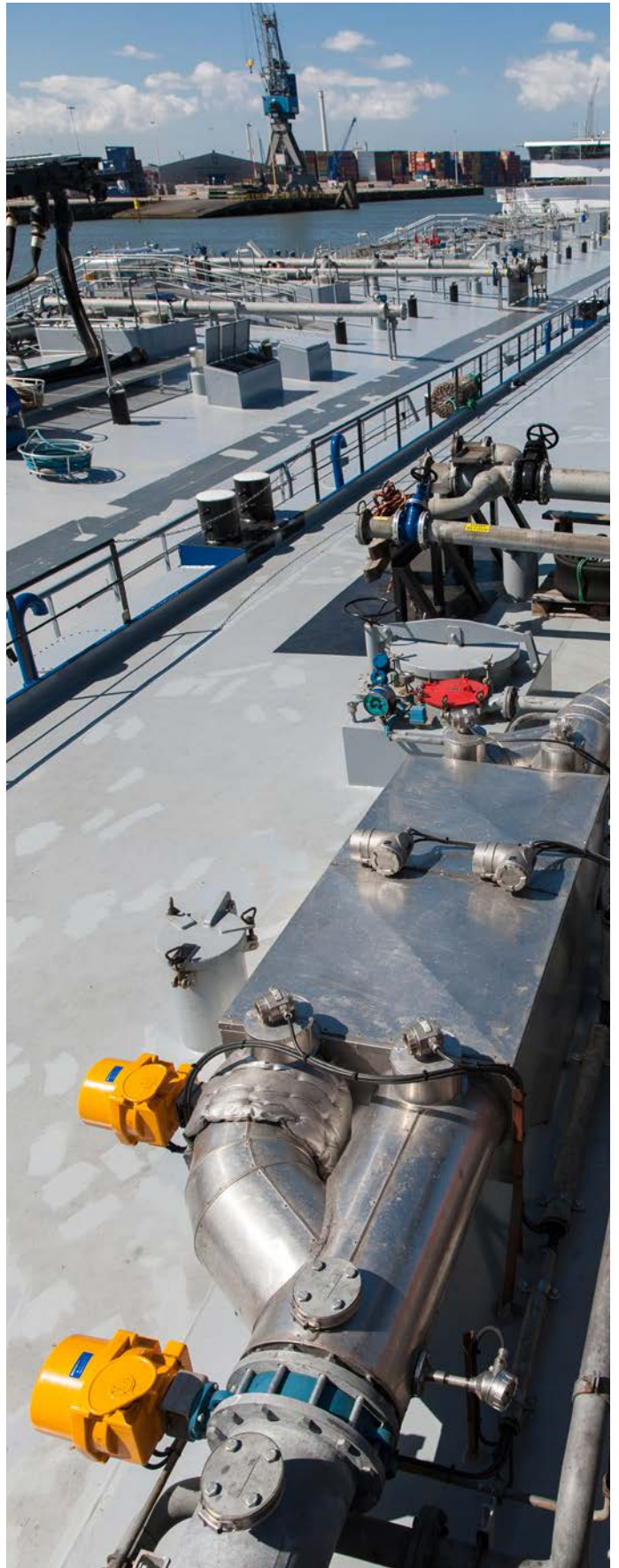
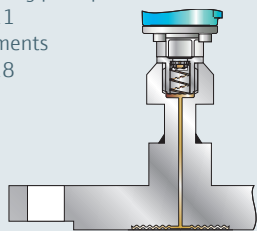

Endress+Hauser measuring cell technology

The right measuring cell for every application

Ceramic measuring cell

The ceramic measuring cell is a dry measuring cell, i.e. the process pressure acts directly on the robust ceramic process membrane and deflects it. A pressure-dependent change in capacitance is measured at the electrodes of the ceramic substrate and the process isolating membrane. The measuring range is determined by the thickness of the ceramic process isolating membrane.

! Advantages

- Extremely good chemical compatibility and high mechanical stability thanks to ultra-pure 99.9 % ceramic
- Suitable for vacuums, dry
- Robust membrane with integrated membrane breakage detection

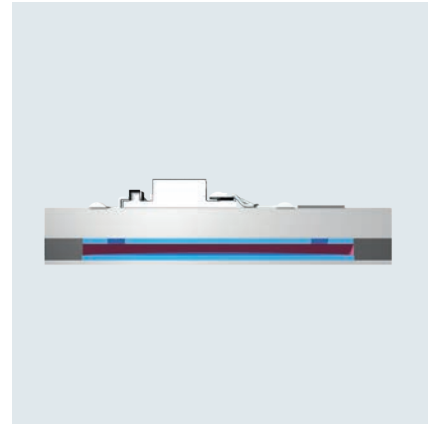

Metallic measuring cell

The operating pressure deflects the process isolating membrane and a fill fluid transfers the pressure to a resistance bridge (semiconductor technology). The pressure-dependent change in the bridge output voltage is measured and evaluated.

! Advantages

- For process pressures up to 700 bar (10,500 psi)
- Small flush-mount process connections
- Guaranteed overload resistance
- Minimal thermal effects

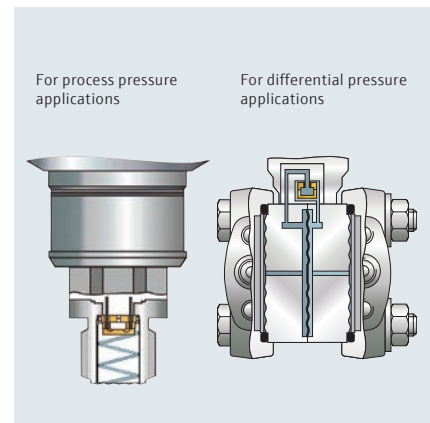

Contite measuring cell

In contrast to conventional gauge pressure measuring cell, the precision measuring element in the Contite measuring cell is absolutely protected between the process membrane and the rear membrane. Thanks to this hermetic sealing of the measuring element, the Contite measuring cell is absolutely insensitive to condensate/condensation and aggressive gases.

! Advantages

- Maximum plant safety provided by one-of-a-kind, condensate-proof Contite measuring cell
- Very good reproducibility and long-term stability even after temperature shocks



Diaphragm seal

The operating pressure acts on the process isolating membrane of the diaphragm seal and is transferred to the process isolating membrane of the measuring cell by a diaphragm seal fill fluid.

The new TempC membrane minimizes the influence of process and ambient temperature fluctuations.

! Advantages

- Variety of special materials and process connections
- Process temperatures from -70 up to +400 °C (-94 up to +752 °F)

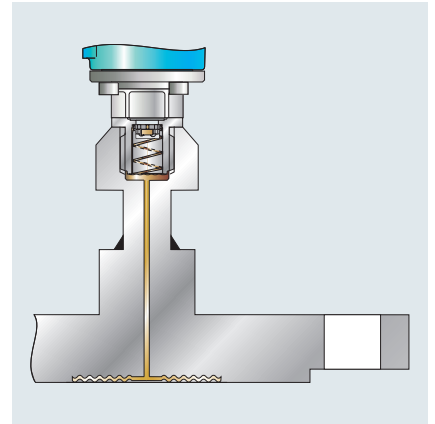

Electronic dp

Deltabar electronic dp is a differential pressure system comprising two sensor modules and one transmitter. In level applications, the high pressure sensor (HP) measures the hydrostatic pressure. The low pressure sensor (LP) measures the head pressure. The level or differential pressure is calculated in the transmitter using these two digital values.

! Advantages

- Better accuracy/reproducibility and cost of ownership compared to capillary and impulse pipe installations
- Fewer spare parts – replace individual components of the system as needed

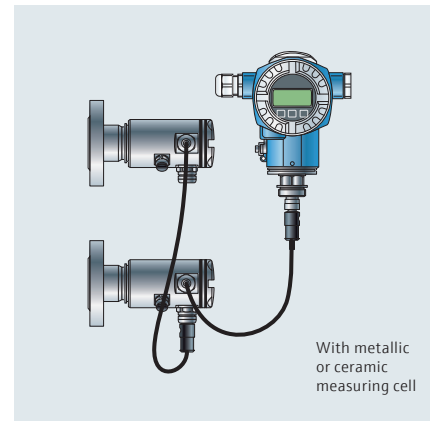

Pressure switch

The pressure switch opens or closes an electrical PNP contact when a certain set pressure has been reached. In addition, a 4 to 20 mA output is available.

! Advantages

- Function check and on-site information with LEDs and digital display
- Fully backlit display for easy visibility
- Capacitive push buttons reduce risk of humidity ingress



Ceraphant pressure switch with ceramic or metallic measuring cell

Over 30 years of knowledge and experience in pressure measurement have naturally left a mark in the development of Ceraphant, with the right amount of innovation at the right point, as in the hallmark of Endress+Hauser products. Ceraphant provides safe measurement and monitoring of absolute and gauge pressure in gas, steam and liquid.

The different process connection versions offer fast, easy and safe integration to the process. The Ceraphant is equipped with an illuminated display as standard. The measured values are visualized with the corresponding unit. Commissioning is sure and simple with operating keys. Pre-configured measuring ranges and switch points are also available.



The Ceraphant portfolio of absolute and gauge pressure switch



- 1**
Ceraphant PTC31B
Cost-effective pressure switch with oil-free ceramic measuring cell for measurement in gases or liquids
- Process temperature:
-25 up to +100 °C (-13 up to +212 °F)
 - Measuring ranges:
+100 mbar up to +40 bar (+1.5 up to +600 psi)
 - Reference accuracy: ±0.5 %/±0.3 %

- 2**
Ceraphant PTP31B
Cost-effective pressure switch with fully welded metallic measuring cell for measurement in gases, steam or liquids
- Process temperature:
-40 up to +100 °C (-40 up to +212 °F)
 - Measuring ranges:
+400 mbar up to +400 bar (+6 up to +6,000 psi)
 - Reference accuracy: ±0.5 %/±0.3 %

- 3**
Ceraphant PTP33B
Cost-effective pressure switch with fully welded metallic measuring cell for use in hygienic applications
- Process temperature: -10 up to +100 °C (+14 up to +212 °F), 135 °C (275 °F) for max. 1 h
 - Measuring ranges:
+400 mbar up to +40 bar (+6 up to +600 psi)
 - Reference accuracy: ±0.5 %/±0.3 %

Advantages Ceraphant

- Quick and flexible process connection
- Function check and on-site information with LEDs and digital display
- Precise measuring/switching

Cerabar with ceramic measuring cell

Ceramic is one of the hardest materials in the world and ensures the best material properties for the medium. Endress+Hauser capacitance ceramic measuring cells have membranes up to 30 times thicker than conventional measuring cells. Even the tiniest of deflections result in measuring signals with the highest accuracy.

The property of the ultra-pure ceramic (99.9 %) guarantees high resistance to corrosion, minimal temperature hysteresis and the best overload resistance. The oil-free measuring cell is the best solution for high vacuum applications. The integrated membrane breakage detection means additional safety in critical applications.

The unique condensation-proof design of the Cerabar PMC51 allows the usage of ceramic also in cold media with condensation formation in the food & beverage industry.

Also available with mounted block and bleed valve.



The Cerabar portfolio for absolute, gauge and hydrostatic pressure with ceramic measuring cell



1
Cerabar PMC11/PMC21
Cost-effective pressure transducer with oil-free ceramic measuring cell

- Process temperature: -25 up to +100 °C (-13 up to +212 °F)
- Measuring ranges: 100 mbar up to +40 bar (1.5 up to +600 psi) gauge or absolute
- Reference accuracy: $\pm 0.5\%$ / $\pm 0.3\%$

2
Cerabar PMC51
Digital pressure transmitter with oil-free ceramic measuring cell

- Process temperature: -25 up to +130 °C (-13 up to +266 °F), 150 °C (302 °F) for 1 h
- Measuring ranges: 100 mbar up to +40 bar (1.5 up to +600 psi) gauge or absolute
- Reference accuracy: $\pm 0.15\%$, "Platinum" $\pm 0.075\%$

3
Cerabar PMC51B
Digital pressure transmitter with oil-free ceramic measuring cell

- Process temperature: -40 up to +100 °C (-40 up to +212 °F)
- Measuring ranges: 100 mbar up to +40 bar (1.5 up to +600 psi) gauge or absolute
- Reference accuracy: up to $\pm 0.055\%$

4
Cerabar PMC71
Digital pressure transmitter with oil-free ceramic measuring cell

- Process temperature: -25 up to +150 °C (-13 up to +302 °F)
- Measuring ranges: 100 mbar up to +40 bar (1.5 up to +600 psi) gauge or absolute
- Reference accuracy: $\pm 0.05\%$, "Platinum" $\pm 0.025\%$

5
Cerabar PMC71B
Digital pressure transmitter with oil-free ceramic measuring cell

- Process temperature: -25 up to +150 °C (-13 up to +302 °F)
- Measuring ranges: 100 mbar up to +40 bar (1.5 up to +600 psi) gauge or absolute
- Reference accuracy: up to $\pm 0.025\%$

Advantages Cerabar with ceramic measuring cell

- Fully vacuum resistant
- High corrosion resistance
- Integrated membrane breakage detection
- Measuring ranges from 100 mbar up to 40 bar (1.5 up to 600 psi)
- Aseptic connections and FDA-conforming materials available
- Condensation-proof version available

Cerabar with metallic measuring cell

As a high-performance solution for high pressure applications up to 700 bar (10,500 psi) and with the availability of small flush-mount process connections, these pressure transmitters meet the highest requirements and work reliably across a large temperature range.

Also available with mounted block and bleed valve.



The Cerabar portfolio for absolute, gauge and hydrostatic pressure with metallic measuring cell



- 1 2**
Cerabar PMP11/PMP21/PMP23
 Cost-effective pressure transducer with fully welded metallic measuring cell
- Process temperature: -40 up to +100 °C (-40 up to +212 °F), 135 °C (275 °F) for max. 1 h
 - Measuring ranges: +400 mbar up to +400 bar gauge or absolute (+6 up to +6,000 psi)
 - Reference accuracy: ±0.5 %/±0.3 %

- 3**
Cerabar PMP51
 Digital pressure transmitter with fully welded metallic measuring cell
- Process temperature: -40 up to +130 °C (-40 up to +266 °F), 150 °C (302 °F) for 1 h
 - Measuring ranges: +400 mbar up to +400 bar gauge or absolute (+6 up to +6,000 psi)
 - Reference accuracy: ±0.15 %, "Platinum" ±0.075 %

- 4**
Cerabar PMP51B
 Digital pressure transmitter with fully welded metallic measuring cell
- Process temperature: -40 up to +125 °C (-40 up to +257 °F)
 - Measuring ranges: +400 mbar up to +400 bar gauge or absolute (+6 up to +6,000 psi)
 - Reference accuracy: up to ±0.055 %

- 5**
Cerabar PMP71
 Digital pressure transmitter with fully welded metallic measuring cell
- Process temperature: -40 up to +125 °C (-40 up to +257 °F)
 - Measuring ranges: +100 mbar up to +700 bar (+1.5 to +10,500 psi)
 - Reference accuracy: ±0.05 %, "Platinum" ±0.025 %

Advantages Cerabar with metallic measuring cell

- Measuring ranges from 400 mbar up to 700 bar (6 psi up to 10,500 psi)
- Temperature ranges from -70 up to 400 °C (-94 up to +752 °F) with diaphragm seal

- 6**
Cerabar PMP71B
 Digital pressure transmitter with fully welded metallic measuring cell
- Process temperature: -40 up to +125 °C (-40 up to +257 °F)
 - Measuring ranges: +400 mbar up to +700 bar gauge or absolute (+6 up to +10,500 psi)
 - Reference accuracy: up to ±0.025 %

Cerabar with diaphragm seals

If measurement is to take place under extreme conditions, a variety of diaphragm seals are available for the direct mounting or with capillary extension. They can be used for media temperatures from -70 up to 400 °C (-94 up to 752 °F), are insensitive to aggressive, highly viscous, crystallizing or polymerizing media and are suitable for measuring points that are difficult to access. Our experts optimize the measuring systems to ensure the maximum degree of performance and reliability. The degree of variance and flexibility in membrane materials, process connections (e.g. extension tube) and connection type (e.g. compact, via temperature isolator or via capillary) allow a wide range of applications.

The free-of-charge software **Applicator Sizing Diaphragm Seal** allows an easy layout and optimization of diaphragm seal systems. Application limits and response times are shown as a function of temperature.

The patented **TempC** membrane minimizes ambient and process temperature effects on the signal output.



The Cerabar portfolio for absolute, gauge and hydrostatic pressure with diaphragm seals



7

Cerabar PMP51B

Digital pressure transmitter with fully welded diaphragm seal

- Process temperature: -40 up to $+400$ °C (-40 up to $+752$ °F)
- Measuring ranges: $+400$ mbar up to $+400$ bar gauge or absolute ($+6$ up to $+6,000$ psi)
- Reference accuracy: up to ± 0.075 %

8

Cerabar PMP55

Digital pressure transmitter with fully welded diaphragm seal

- Process temperature: -70 up to $+400$ °C (-94 up to $+752$ °F)
- Measuring ranges: $+400$ mbar up to $+400$ bar ($+6$ up to $+6,000$ psi)
- Reference accuracy: ± 0.15 %, "Platinum" ± 0.075 %

9

Cerabar PMP75

Digital pressure transmitter with fully welded diaphragm seal

- Process temperature: -70 up to $+400$ °C (-94 up to $+752$ °F)
- Measuring ranges: $+400$ mbar up to $+400$ bar ($+6$ up to $+6,000$ psi)
- Reference accuracy: ± 0.075 %

10

Cerabar PMP71B

Digital pressure transmitter with fully welded diaphragm seal

- Process temperature: -40 up to $+400$ °C (-40 up to $+752$ °F)
- Measuring ranges: $+400$ mbar up to $+700$ bar gauge or absolute ($+6$ up to $+10,500$ psi)
- Reference accuracy: up to ± 0.075 %



For selection and sizing of diaphragm seals, use www.endress.com/applicator

Deltapilot with Contite measuring cell

The Contite measuring cell has been specially developed for hydrostatic level measurement based on silicon technology.

With its protection for transmitter and measuring cell electronics, the Contite measuring cell is a convincing solution in the event of severe moisture and condensate formation. The measuring element itself is protected and hermetically sealed between the process membrane and rear membrane. The process membrane is of Hastelloy C and, thanks to its clever design, insensitive to any kind of build-up.

Compact versions with flush-mount process connections are available as well as rod and rope versions with a fixed process connection or rope versions for mounting with suspension clamp.



The Deltapilot portfolio for gauge and hydrostatic pressure with Contite measuring cell



- 1**
Deltapilot FMB50
Pressure transmitter with the Contite measuring cell for hydrostatic level measurement. Compact version
- Process temperature: -10 up to +100 °C (14 to +212 °F), 135 °C (275 °F) for max. 30 minutes
 - Measuring ranges: 100 mbar up to 10 bar gauge/100 m H₂O (1.5 up to 150 psi/300 ft H₂O)
 - Reference accuracy: ±0.2 %, "Platinum" ±0.1 %

- 2**
Deltapilot FMB51
Pressure transmitter with the Contite measuring cell for hydrostatic level measurement. Rod version
- Process temperature: -10 up to +85 °C (-14 up to +185 °F)
 - Measuring ranges: 100 mbar up to 10 bar gauge/100 m H₂O (1.5 up to 150 psi/300 ft H₂O)
 - Reference accuracy: ±0.2 %, "Platinum" ±0.1 %

- 3**
Deltapilot FMB52
Pressure transmitter with the Contite measuring cell for hydrostatic level measurement. Cable version
- Process temperature: -10 up to +70 °C (14 up to +158 °F)
 - Measuring ranges: 100 mbar to 10 bar gauge/100 m H₂O (1.5 up to 150 psi/300 ft H₂O)
 - Reference accuracy: ±0.2 %, "Platinum" ±0.1 %

- 4**
Deltapilot FMB53
Pressure transmitter with the Contite measuring cell for hydrostatic level measurement. Cable version
- Process temperature: -10 up to +70 °C (14 up to +158 °F), with FEP cable up to +80 °C (176 °F)
 - Measuring ranges: 100 mbar up to 10 bar gauge/100 m H₂O (1.5 up to 150 psi/300 ft H₂O)
 - Reference accuracy: ±0.2 %, "Platinum" ±0.1 %

✓ Advantages Deltapilot

- Highest accuracy and reproducibility, also after extreme ambient and process temperature changes
- Contite measuring cell: Waterproof, climate-resistant and long-term stable
- Compact stainless steel or aluminum housing
- Rod/rope versions for installation from the top

- 5**
Deltapilot FMB70
Highest performance pressure transmitter with the Contite measuring cell for hydrostatic level measurement. Compact version
- Process temperature: -10 up to +100 °C (14 up to +212 °F), 135 °C (275 °F) for max. 30 minutes
 - Measuring ranges: 100 mbar up to 10 bar rel. (1.5 up to 150 psi)
 - Reference accuracy: ±0.1 %, "Platinum" ±0.075 %

Deltabar electronic dp with ceramic or metallic measuring cell

Differential pressure measurement is often used to measure the level in pressurized and vacuum tanks. Traditional differential pressure measurement using impulse lines and capillaries has issues that can lead to less accuracy, process safety risks and greater total cost of ownership. This can be especially true in tall distillation towers or other vessels with varying ambient temperatures.

Eliminate typical mechanical issues of impulse lines like icing up, clogging, leaky tabs and dry/wet leg inconsistencies as well as temperature effects in capillary systems with the new electronic differential pressure system. Costs are also optimized as no system recalibration or reconfiguration are required with any component change, fewer spare parts are necessary, just one technician can install entire system and there is no need for freeze protection/heat tracing.



The Deltabar electronic dp portfolio for differential and hydrostatic pressure with metallic or ceramic measuring cells

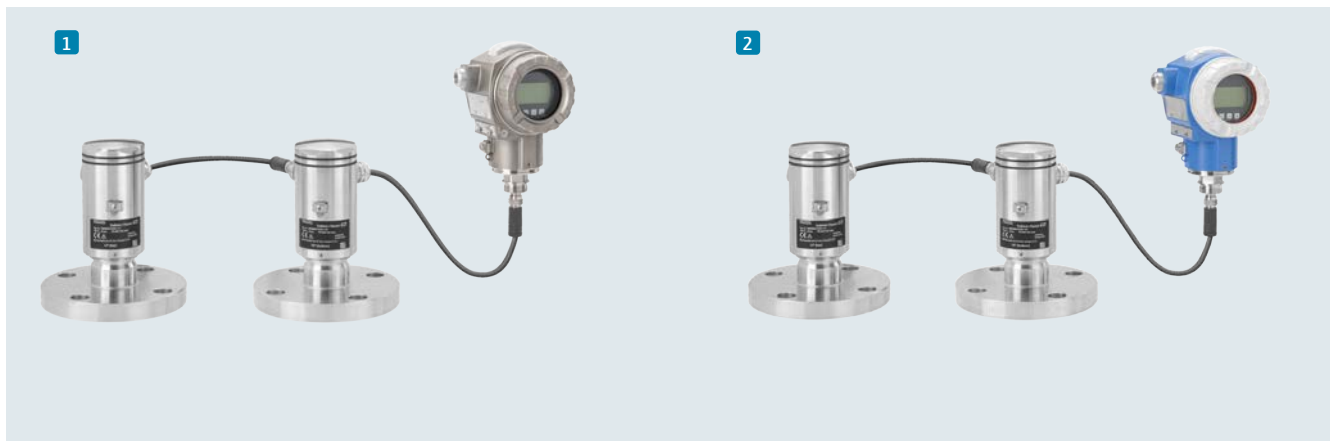

1

Electronic dp Deltabar FMD71

Electronic differential pressure system utilizing two ceramic sensor modules and one transmitter

- Process temperature: -25 up to +150 °C (-13 up to +302 °F)
- Measuring ranges: 100 mbar up to 40 bar (1.5 up to 600 psi)
- Reference accuracy: Single sensor up to ± 0.05 %, system up to ± 0.07 %

2

Electronic dp Deltabar FMD72

Electronic differential pressure system utilizing two fully welded metallic sensor modules and one transmitter

- Process temperature: -40 up to +125 °C (-40 up to +257 °F); with diaphragm seal up to +260 °C (500 °F)
- Measuring ranges: 400 mbar up to 40 bar (6 up to 600 psi)
- Reference accuracy: Single sensor up to ± 0.05 %, system up to ± 0.07 %

✓ Advantages Deltabar electronic dp

- The electronic differential pressure system eliminates traditional mechanical issues resulting in greater process availability and reliability
- Safety risks are minimized with the electronic differential pressure system architecture and design
- Lowest total cost of ownership due to reduced installation time, maintenance, downtime and spare requirements



For selection and sizing of electronic dp systems, use www.endress.com/applicator

Deltabar with metallic measuring cell

The Deltabar differential pressure cell is used for level, volume or mass measurements in liquids using impulse piping, for flow measurements (volume or mass flow) and for differential pressure monitoring applications such as filters and pumps.

The function-monitored measuring cell with high overpressure rating allows accurate measurement of small differential pressures in combination with high one-sided or two-sided static pressures.



The Deltabar portfolio for differential pressure with metallic measuring cell



1

Deltabar PMD55

Differential pressure transmitter with metallic measuring cell for measurement of pressure differences

- Process temperature: -40 up to +85 °C (-40 up to +185 °F)
- Measuring ranges: 10 mbar up to +40 bar differential pressure (0.15 up to +600 psi)
- Reference accuracy: ±0.1 %, "Platinum" ±0.075 %

2

Deltabar PMD55B

Differential pressure transmitter with metallic measuring cell for measurement of pressure differences

- Process temperature: -40 up to +110 °C (-40 up to +230 °F)
- Measuring ranges: 30 mbar up to 40 bar differential pressure (0.45 up to 600 psi)
- Reference accuracy: up to ±0.055 %

3

Deltabar PMD75

Differential pressure transmitter with metallic measuring cell for measurement of pressure differences

- Process temperature: -40 up to +85 °C (-40 up to +185 °F)
- Measuring ranges: 10 mbar up to 40 bar differential pressure (0.15 up to 600 psi) 160 bar up to 250 bar absolute (2,320 up to 3,750 psi)
- Reference accuracy: ±0.05 %, "Platinum" ±0.035 %

4

Deltabar PMD75B

Differential pressure transmitter with metallic measuring cell for measurement of pressure differences

- Process temperature: -40 up to +110 °C (-40 up to +230 °F)
- Measuring ranges: 10 mbar up to 40 bar differential pressure (0.15 up to 600 psi); 100 mbar up to 250 bar (1.5 up to 3,750 psi) gauge and absolute
- Reference accuracy: up to ±0.035 %



Advantages Deltabar

- Highest accuracy and long-term stability
- Overload up to 420 bar/630 bar (6,090 psi/9,135 psi) on one or both sides
- Modular electronics, displays and sensors
- Mounted manifolds with documented leakage test

Deltabar with diaphragm seals

Differential pressure transmitters with one or two diaphragm seals are most often used for level measurement in pressurised tanks with high static pressures and/or in applications where flush-mounted process connections are required. They can be used for media temperatures from -70 up to 400 °C (-94 up to 752 °F), are insensitive to aggressive, highly viscous, crystallizing or polymerizing media. Our experts optimize the measuring systems to ensure the maximum degree of performance and reliability. The degree of variance and flexibility in membrane materials and process connections (e.g. extension tube) allow a wide range of applications.

The free-of-charge software Applicator Sizing Diaphragm Seal allows an easy layout and optimization of diaphragm seal systems. Application limits and response times are shown as a function of temperature.

The patented TempC membrane minimizes ambient and process temperature effects on the signal output.



The Deltabar portfolio for differential and hydrostatic pressure with diaphragm seals

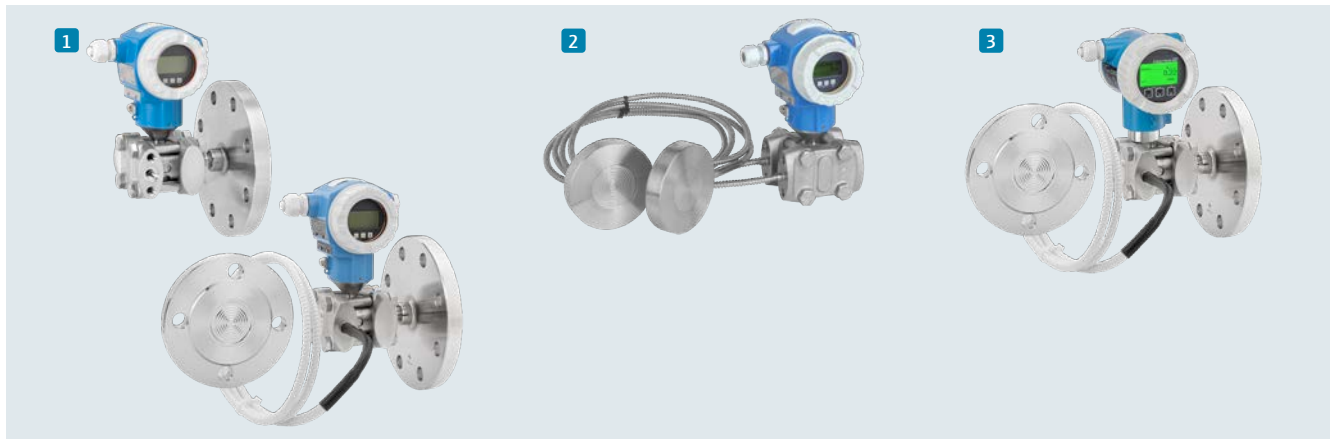

1

Deltabar FMD77

Differential pressure transmitter with one or two asymmetric diaphragm seals

- Process temperature: -70 up to +400 °C (-94 up to +752 °F)
- Measuring ranges: 100 mbar up to 16 bar (1.5 up to 240 psi)
- Reference accuracy: $\pm 0.075\%$

2

Deltabar FMD78

Differential pressure transmitter with two diaphragm seals for measurement of pressure differences and level

- Process temperature: -70 up to +400 °C (-94 up to +752 °F)
- Measuring ranges: 100 mbar up to 40 bar (1.5 up to 600 psi)
- Reference accuracy: $\pm 0.075\%$

3

Deltabar PMD78B

Differential pressure transmitter with two diaphragm seals for measurement of pressure differences and level

- Process temperature: -70 up to +400 °C (-94 up to +752 °F)
- Measuring ranges: 100 mbar up to 240 bar (1.5 up to 3,600 psi) on both sides
- Reference accuracy: $\pm 0.075\%$



Advantages Deltabar with diaphragm seals

- Temperature ranges from -70 up to 400 °C (-94 up to +752 °F)
- Diaphragm seals on one or both sides available
- TempC membrane for minimized temperature effects
- Asymmetric diaphragm seals and diaphragm seals with different process connections available
- High variety of membrane materials
- Coated capillaries for use in harsh environment
- Volume optimized transmitter



For selection and sizing of diaphragm seals, use www.endress.com/applicator

Waterpilot with ceramic measuring cell

Level measurement in deep wells is a typical application for the Waterpilot. Waterpilot – that means level measurement certified for drinking water with a robust ceramic measuring cell and integrated temperature measurement, all combined on a diameter of just 22 mm (0.9"). As a result, the smallest of wells can be used for the application.

A robust design for applications in wastewaters and sludges or a design free of metal with long-term stability for usage in salt water is also available. Intelligent application solutions also means using the right accessories. The know-how behind many applications is invested in the extensive range of accessories to provide the optimal solution for your measuring tasks.



The Waterpilot portfolio for hydrostatic pressure with ceramic measuring cell



- 1**
Waterpilot FMX11
Reliable level probe with metallic measuring cell
- Process temperature:
-10 up to +70 °C (14 up to +158 °F)
 - Measuring ranges: 200 mbar up to 2 bar
(3 up to 30 psi)
 - Reference accuracy: up to ±0.35 %

- 2**
Waterpilot FMX21
Reliable and robust level probe with ceramic measuring cell and optional HART communication and temperature sensor
- Process temperature:
-10 up to +70 °C (14 up to +158 °F)
 - Measuring ranges: 0 up to 20 bar/200 m H₂O
(0 up to 300 psi/600 ft H₂O)
 - Reference accuracy: ±0.2 %, "Platinum" ±0.1 %

Advantages Waterpilot

- Robust stainless steel housing with the smallest of probe diameters
- Materials in conformity with drinking water directives
- Extensive measuring point accessories

Accessories for pressure / differential pressure

Deltabar transmitters can be combined with manifolds, orifice plates, pitot tubes, nozzles and venturies as primary elements. The layout can be optimized with the free of charge Applicator software.

 www.endress.com/applicator

A wide range of shut-off valves, siphons, manifolds and tank spuds for Cerabar / Deltabar assures that everything fits and is available on site. It may be ordered separately or with transmitter as an accessory enclosed or mounted.



Accessories

Tank spuds	Manifolds* DA63M	Shut-off valves* DA61V DA63M PZAV	Condensate pot DA61C	
				
Mounting bracket	Weather protection cover	Flushing rings	Siphons	Weld-in adapters
				

Thanks to our comprehensive portfolio of accessories and assemblies in various materials and versions, your measuring point can be completely equipped. We are pleased to help you in designing your measuring point or use www.endress.com/applicator

* Also available mounted to Cerabar/Deltabar



Endress+Hauser в России:

www.avtsv.ru

Контактная информация

ООО «АвтоматикаСервис»
454008, Челябинская обл.,
г. Челябинск, ул. Косарева,
дом 2, офис 604

www.avtsv.ru

Телефон: +7 (351) 776-17-98
Мобильный: +7 922 696-05-95
E-mail: для общих вопросов: info@avtsv.ru;
для заказа продукции: sakas@avtsv.ru